



T&S BRASS AND BRONZE WORKS, INC.

2 Saddleback Cove / P.O. Box 1088
 Travelers Rest, SC 29690



REG. #A2601
 ISO #9001

Model No.

EA-2DF12-300

Item No.

Travelers Rest, SC: 800-476-4103 • Simi Valley, CA: 800-423-0150 • Fax: 864-834-3518 • www.tsbrass.com

This Space for Architect/Engineer Approval

Job Name _____ Date _____

Model Specified _____ Quantity _____

Customer/Wholesaler _____

Contractor _____

Architect/Engineer _____

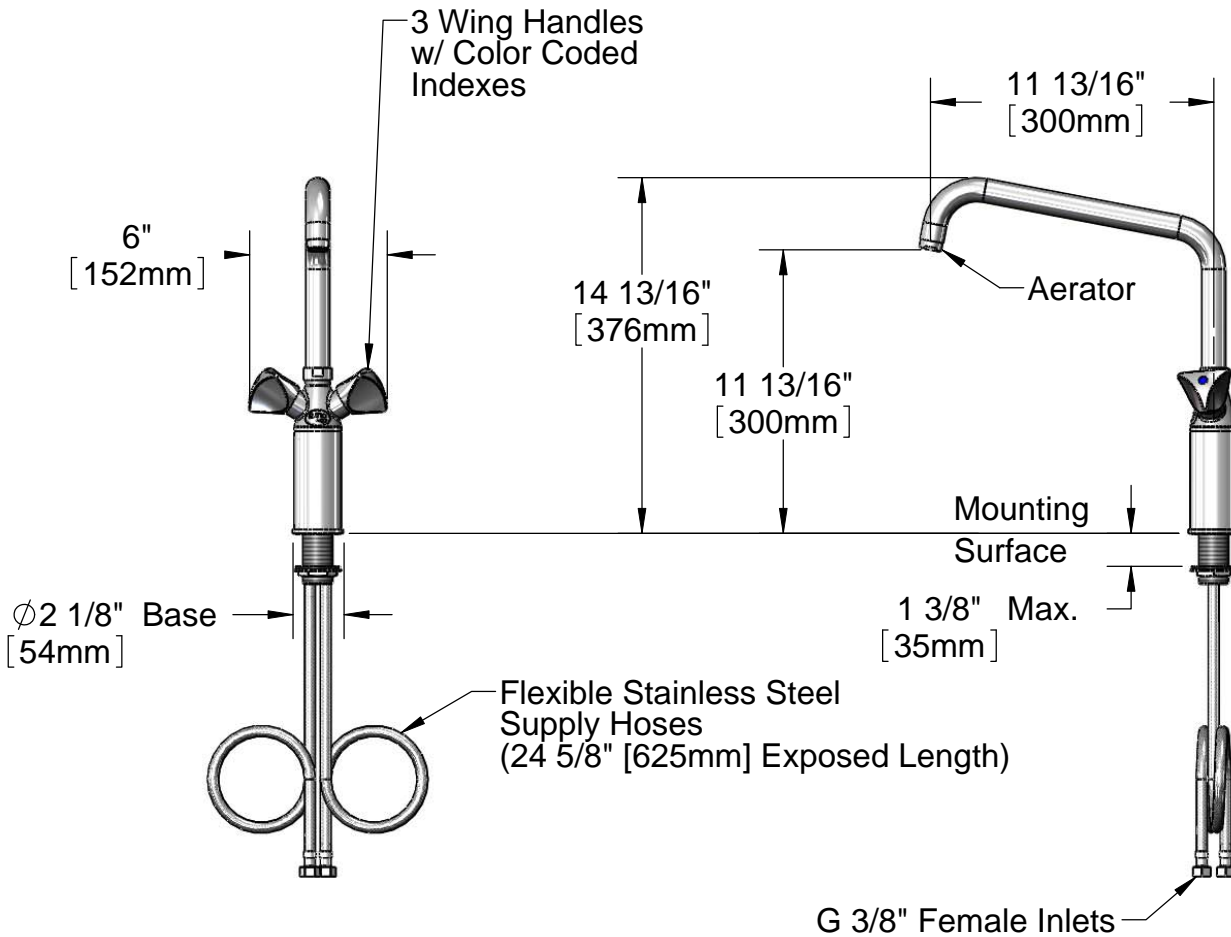

Rough-In Requirement:
 Ø 1 1/2" [38mm] Hole

Product Specifications:
 Two Handle Deck Mount Pot Filler Faucet w/ 12" Swing Nozzle & 300mm Clearance

Drawn DMH	Checked KJG	Approved JHB
Scale: 1:8		Date: 03/23/11